



Science Archives (ISSN: 2582-6697)

Journal homepage: [www.sciencearchives.org](http://www.sciencearchives.org)



Review Article

<http://dx.doi.org/10.47587/SA.2022.3101>



## Monobactams as anticancer: a review study

Ahmed A. J. Mahmood 

Department of Pharmaceutical Chemistry,  
College of Pharmacy, University of Mosul, Mosul, Iraq

✉ [ahmedsot@gmail.com](mailto:ahmedsot@gmail.com)

Received: Dec 4, 2021 / Revised: Jan 15, 2022/ Accepted: Jan 20, 2022

### Abstract

Cancer is a heterogeneous disease which categories as the second-leading cause of death worldwide. It is fatal to 42% of diagnosed patients every year. The ideal anticancer agents needed to be powerful, well-tolerated in patients, with low side effects and high selectivity. Antibiotics on the other hand are efficient, well-tolerated, with a very low level of toxicity. Therefore, they continue to be the most important goal for new drugs invention. 2-Azetidinones ( $\beta$ -lactams) are most marketing drugs than any other antibiotics. The  $\beta$ -lactams provide unlimited choices of biological activities, and they are efficaciously used as anticancer agent delivery systems directly to the tumor sites as pro-drugs. These records indicate that the designation and synthesis of new monobactams will be a favorable zone for improvement anticancer studying research.

**Keywords** Monobactams,  $\beta$ -lactams, 2-Azetidinones, Anticancer

### Introduction

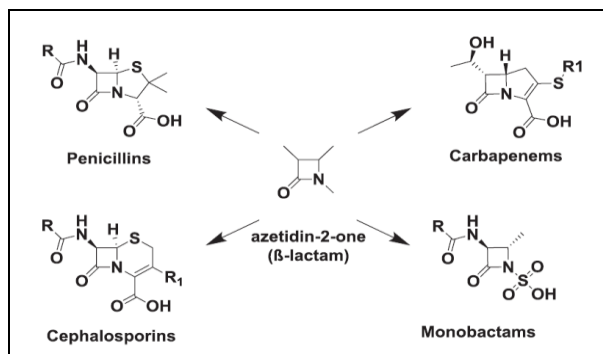
Cancer is a mixed disease and is considered as the major threat to human health in 20<sup>th</sup> and 21<sup>th</sup> centuries, it is classified as the 2<sup>nd</sup> trigger of death worldwide. Cancer is described as the malignant cell progression that at the last leads to change the regular physiological activities (Kuhn et al., 2004). Antimalignant agent investigation concentrates on reducing tumor cell growth rate and initiation of apoptosis in malignant cells. Programmed cellular death (apoptosis) is described as the capability of a cell to undertake a step-by-step self-suicide program without disturbing adjacent cells (Kuhn et al., 2004; Dong et al., 2019). Initiation of such apoptotic action in malignant cells is very necessary for the cancer management process (Dong et al., 2019).

The percentage of death in cancer diagnosed patient is high and it is approximately about 42%. Therefore there is an urgent need to introduce new and safe anticancer agents, and this concenter as an objective for medical research (Sharipova et al., 2019).

However, nowadays cancer treatments are almost as hazardous as the disease itself caused by the incapability of the currently existing chemotherapeutic agents to target the cancer cells away from the normal cell (Vento and Cainelli, 2003). Another drawback of cancer treatments is the critical unwanted effects of the anticancer agents as they weaken the immune system caused by neutrophil cells decline (Vento and Cainelli, 2003; Tikhomirov et al., 2018). The ideal anticancer agents needed to be powerful, well-tolerated in patients, with low side effects and high tumor cells selectivity.

The innovation of natural and synthetic antibiotics is one of the most significant medical discoveries in human history (Mehta et al., 2010). Antibiotics are efficient, mostly well tolerated in patients, with a very low level of toxicity. This is why antibiotics continue to be the main aim for drug invention (Basu and Banik, 2017). 2-Azetidinones ( $\beta$ -lactams) are the most famous antibacterial compounds and they are the most marketing antibiotics drugs (Basu and Banik, 2017; Zhou et al., 2018). The  $\beta$ -Lactams category includes penicillins, cephalosporins, carbapenems, and monobactams, all with a rigid ring structure (Fig.1) (Zhou et al., 2018).

Their antimicrobial action is a result of inhibiting the peptidoglycan enzyme and thus inducing cell wall damage (Borazjani et al., 2019). Around the year 1981, a couple of teams belonging to the Squibbs and Takeda laboratories define and isolate the initial *N*-thiolated monobactams from natural resources (Tripodi, 2018). These monobactams were the first with the *N*-sulfonic acid substituent that attached directly to the nitrogen atom. They possess a flexible monocyclic structure.

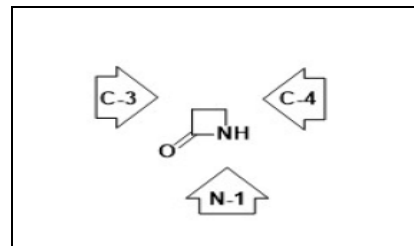


**Fig.1 The  $\beta$ -Lactams categories**

Nowadays,  $\beta$ -lactam compounds offering an extensive range of biological activities (Hammersley and Signy, 2017). The new drug with monobactam moiety Ezetimibe selectively inhibits intestinal cholesterol absorption (Hammersley and Signy 2017; Chen et al., 2008). Moreover, many studies indicate that several antibiotics are qualified to inhibit the growth of tumor cells. In addition to many antitumor antibiotics approved nowadays for cancer treatment, they interacted with DNA leading to inhibit tumor cell growth (Chen et al., 2008; Tripodi, 2018). Recently, a new class of *N*-thiolated monobactams was used to prompt apoptosis powerfully in a specific manner in many lines of tumor cells but they do not do so in non-transformed cell lines (Tripodi, 2018; Banik et al., 2003). These records indicate that the designation and synthesis of new monobactams will be the favorable zone for improvement anticancer research (Banik et al., 2003).

The monobactams structural moiety has attracted a great deal of attention owing to their extensive biological activities (Trivedi et al., 2012; Pathak et al., 2012; Kumar et al., 2007). In addition, much research indicates that these monobactams are used in an efficacious manner as pro-drugs to deliver the anticancer agents directly to the tumor sites (Ojima and Delalogue, 1997; Hodge et al., 1995; Mahmood, 2021).

Monobactam is a four-membered cyclic amide, at the second position of the ring, there is an oxo group, with various substitutions on the amide nitrogen (N-1), on the carbon neighboring to the carbonyl group (C-3), and on the carbon next to the nitrogen (C-4) (Fig.2) (Kuhn et al., 2004; El-Shorbagi and Chaudhary, 2019).



**Fig.2 The chemical structure of monobactam**

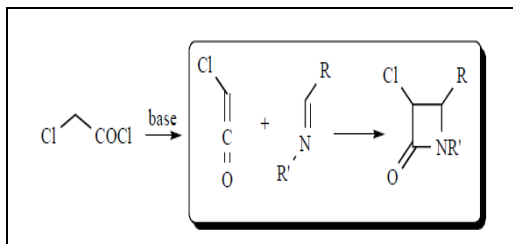
The monobactams reactivity can be controlled by varying the characteristics of the electron-withdrawing substituent (Kuhn et al., 2004). From the mechanistic view, monobactam moiety acts as an electrophilic nucleus targeting serine-containing enzymes (El-Shorbagi and Chaudhary, 2019).

Monocyclic  $\beta$ -lactams were diagnosed to have antimycobacterial, antiprotozoal, antifungal, anti-HIV, anti-inflammatory, anti-tumor, antiparkinsonian, antidiabetic and antidepressant effects. They have been reported as cholesterol absorption inhibitors, vasopressin V1a antagonists, tryptase, chymase, and thrombin inhibitors, human leukocyte elastase and carbonic anhydrase inhibitors, *N*-acylethanolamine acid amidase inhibitors, and also inhibitors of dengue and West Nile virus NS2B-NS3 protease (Trivedi et al., 2012; Pathak et al., 2012; Kumar et al., 2007; Jain et al., 2012; Galletti and Giacomini, 2011; Decuyper et al., 2018; Dražić et al., 2020).

In recent years Tripodi et al., mention the malignant effect of 1,4-Diaryl-2-azetidinones caused by the stimulation of Adenosine Monophosphate Activated Protein Kinase (AMPK) leading to initiate an apoptotic response in colorectal cancer cell lines (Tripodi et al., 2012; Valtorta et al., 2014). Also they indicated these monobactams specifically for the small bowel adenocarcinoma (SBA) and also for the colorectal cancer diseases (CRC), as they all share comparable pathophysiology (Koch et al., 2019; Meegan, 2010). In another study 1,4-diarylazetidin-2-ones were present potent antiproliferative action against MCF-7, MDA-MB-231 human breast carcinoma cell lines (Meegan, 2010; Bimal, 2014; Chavan and Pai, 2007). Other monobactams act as effective antimalignant agents as they provoke DNA destruction and inhibit the replication of the Jurkat T cells DNA (Kamath and Ojima, 2012).

### Synthesis of monobactams

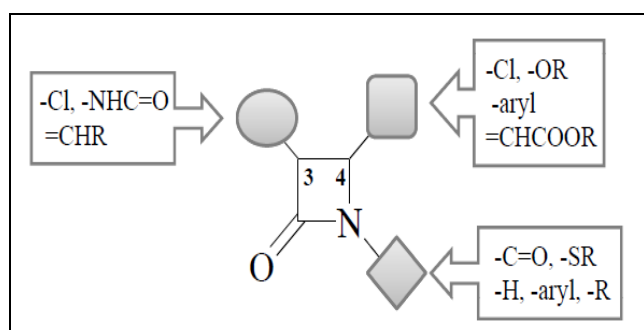
2-azetidinone (monobactams) compounds are synthesized according to [2+2] ketene-imine cyclo addition (Staudinger cyclo addition reaction) (Tanaka et al., 2007). In 1907, this reaction was first reported and defined as a [2+2] cyclo addition involving both a ketene (formed from acid chloride) and suitably substituted imines under basic conditions. This reaction stays as the most commonly used method for its flexibility and efficiency. The required imines were prepared by the reaction of the required substituted benzaldehydes and the aromatic amines (Fig.3) (Tanaka et al., 2007; Mahmood, 2021; Singh, 2003; Lima et al., 2020; Söderström et al., 2002).



**Fig.3 The Staudinger [2+2] ketene-imine cycloaddition reaction**

### Monobactams as anticancers

The general chemical structure for the 2-azetidinones with the possible substitutions on each monobactam corner is clarified in Fig.4.



**Fig.4 The general chemical structure for the 2-azetidinones with the possible substitutions**

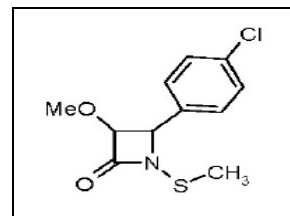
In early 2000, some studies indicate that the *N*-thiolated  $\beta$ -lactams were capable to induce apoptotic reaction in tumor cells by causing DNA destruction and without affecting the normal body cells (Kazi et al., 2004; Cainelli et al., 2003). They found that the *N*-methyl-thio group is very important for such apoptosis-inducing activity. Another study indicates that 4-alkylidene- $\beta$ -lactams could be as inhibited for matrix metalloproteinases-2, and metalloproteinases-9 (MMP) (Chin et al., 1985), both were classes of mammalian proteases, which playing a very critical role in cancer propagation by promoting neovascularization needed for tumor growing (Hojilla et al., 2003; Wilhelm et al., 1987). MMPs activated specifically in malignant cells, and not in normal cells (Chin et al., 1985; Malig et al., 2018).

Banik et al. in 2003 describe a class of polyaromatic imine  $\beta$ -lactams (the 4-alkylideneazetidin-2-ones). Many of these compounds were verified *invitro* for their preventing action against MMP-2 and -9 and human leukocyte elastase (LE) (Zhuang et al., 2017). They conclude that monobactams bearing phenanthrene and chrysene substituents dedicate excellent activity. While naphthalene, anthracene, and pyrene substituents cause no cytotoxic activities (Zhuang et al., 2017).

Kuhn et al. in 2004 describe some of synthetic *N*-methylthio- $\beta$ -lactams that provoke apoptosis in many tumor cell lines as the

breast cancer (MCF-7 and MDA-MB-231) human leukemia Jurkat T cells, head-and-neck (PCI-13), and prostate cells (PC-3 and DU-145) (Frezza et al., 2008). They finally conclude several key points that are to be considered in upcoming purpose and synthesis of monobactams as an anticancer (Fig.5).

- 1) The *N*-methyl-thio group must maintained as it is without any addition.
- 2) All substitutions on *ortho*, *meta*, and *para* of the phenyl ring retain the apoptotic effect, and the most potent are on the *ortho* position.
- 3) The bigger groups in the *ortho* position will cause the powerful apoptotic-inducing activity.



**Fig.5 The structure of Kuhn et al. *N*-methylthio- $\beta$ -lactams**

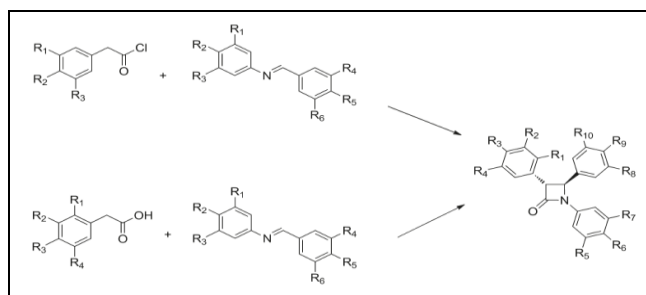
In 2008 Frezza et al. studied the effects of C3 and N1 substitutions on  $\beta$ -lactams moiety for their apoptotic effect with structure-activity relationship (SAR). They mentioned couple of  $\beta$ -lactam compounds, both bearing a branched-chain moiety on C3, they exhibit a potent apoptosis-inducing activity. They concluded that any substituents on the N1 or C3 atoms of the monobactam will further potentiate such an effect (Arya et al., 2014).

Based on studies that mention the anticancer activity of the combretastatin analogues with OH and OMe groups at C-3 (Sun et al., 2004; Carr et al., 2010; Meegan et al., 2008). Also, the potent anticancer action of monobactams compounds that contain methyl group at C-3 (Martelli et al., 2020; Pettit et al., 1987; O'Boyle et al., 2010), O'Boyle et al. in 2010 studied the ant proliferative action of a novel synthesized series of inflexible analogues of natural combretastatin which bearing the 1,4-diaryl-2-azetidinone (monobactams) instead of the regular ethylene link existing in the natural combretastatin stilbene compounds. Moreover, these new compounds substituted with an aryl ring at position 3 on monobactam moiety. Also, the 3,4,5-trimethoxyphenyl moiety introduced at the N-1 atom and the 4-methoxyphenyl ring is hosted at the C-4 atom (Fig.6) (Cerić et al., 2010).

First, these compounds were estimated for their anticancer effect against the MCF-7 human breast cancer cell line, and then the most powerful agents were tested versus the MDA-MB-231 cell line.

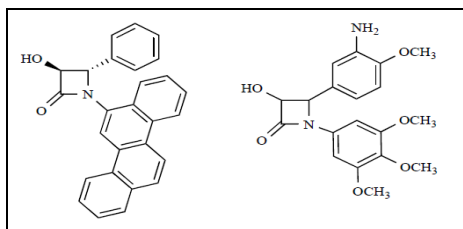
They indicate that the highest effective compounds in this group were established in those with tiny, polar substituents such as (4-fluorophenyl), (4-hydroxyphenyl), (3-hydroxyphenyl), and (4-aminophenyl). The SAR studies indicate that the replacement of the  $\beta$ -lactam carbonyl group

with the thione resulted in a decrease of the antiproliferative activity (Cerić et al., 2010).



**Fig.6** The structure of O'Boyle *et al.* monobactams

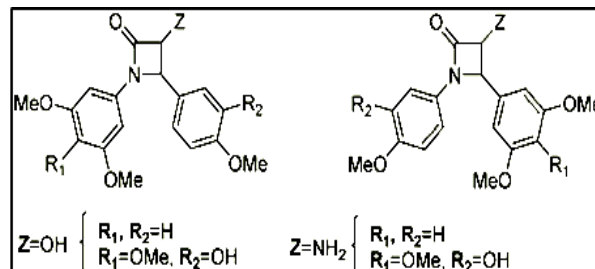
Galletti and Giacomini in their review reported that Banik and its colleague established a new series of *N*-polyaromatic-azetidinones with antitumor actions. Their SAR study exposed that the aromatic structural requirement for cytotoxicity must contain three aromatic rings as a minimum in an rangy configuration (compounds with chrysene substituents established activity, while naphthalene, anthracene, or pyrene substituents with no activities (Banik et al., 2010; Tripodi et al., 2012). Their results reveal that the inhibition of the growth is not equal against all tumor lines, suggesting that there is specificity in the targeting process. In addition, the existence of a OH group on C3 enhanced the activity or even it may switch inactive compound into active ones (Fig.7) (Banik et al., 2010).



**Fig.7** The structure of Banik *et al.* monobactams

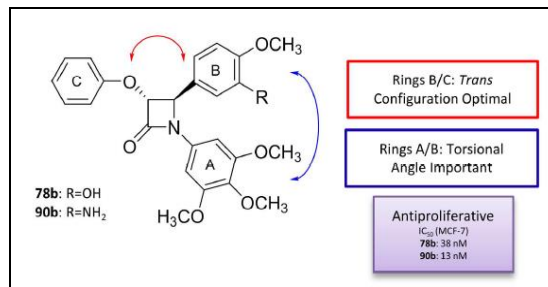
In 2012 Tripodi et al. considered four series of compounds. One with a 3,4,5-trimethoxyphenyl moiety at position 1 accompanied by a 4-methoxy-3-hydroxyphenyl moiety at 4 positions of the monolactam ring and also a OH or HH2 group at position number 3. The other series with 3,5-dimethoxyphenyl moiety accompanied by a 4-methoxyphenyl group at position number 4 of the monobactam ring. The third and fourth series were with the inverted aryl moieties of the first and second series respectively (Fig.7) (Petrovski et al., 2011). All the synthesized products were evaluated against HeLa cells (cervical adenocarcinoma), and also against the breast cancer cell line MCF-7, as well as against several colon cancer cell lines (SW48, SW480, SW620, T84) and finally against the neuroblastoma cell line SKNB6 to estimate their antiproliferative activities (Petrovski et al., 2011; Kondratyuk et al., 2011).

The results indicate that the water solubility of the tested compounds was enhanced by the presence of a OH group at position number 3 of the monobactam ring (Kondratyuk et al., 2011; Meegan et al., 2001). Also, compounds bearing the 3,4,5-trimethoxy or 3,5-dimethoxyphenyl substituents at position 1 (N atom) of monobactam ring represent efficient activity compared to those with polymethoxylated substituents at C-4 position (Kondratyuk et al., 2011).



**Fig.8** The structure of Tripodi *et al.* monobactams

Greene and coworker in 2016 studied the SAR for a new family of 3-phenoxy-1,4-diarylazetidin-2-ones (Olazaran et al., 2017; Barrett et al., 2010) that finally led to synthesize a group of active anticancer compounds involving *trans*-4-(3-hydroxy-4-methoxyphenyl)-3-phenoxy-1-(3,4,5-trimethoxyphenyl) azetidin-2-one and *trans*-4-(3-amino-4-methoxyphenyl)-3-phenoxy-1-(3,4,5-trimethoxyphenyl) azetidin-2-one (Barrett et al., 2010). The anticancer activities were tested against MCF-7 breast cancer cells (targeting tubulin polymerization process) (Barrett et al., 2010; Greene et al., 2016). Their results indicate that these compounds targeted tubulin effectively and that the monobactams synchronize within the colchicine-binding site of the  $\beta$ -tubulin. In addition, and by studying the X-Ray crystallography for several chosen compounds, the results indicate that the torsional angle among the aryl rings at N-1 and C-4 of the monobactams is considered to be essential for effective anticancer effects (Fig.9) (Barrett et al., 2010; Deep et al., 2016).



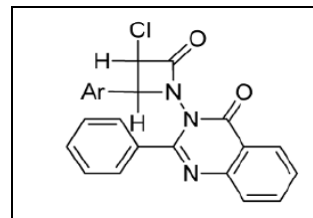
**Fig.9** The structure of Greene and coworker monobactams

Deep and coworkers synthesized another series of monobactams derivatives in 2016 from hippuric acid (Fig.10), they assessed the *in vitro* anticancer activities for these compounds against an estrogen receptor positive human breast adenocarcinoma MCF-7 (ATCC HTB-22) cancer cell line. The results showed a regular anticancer potential



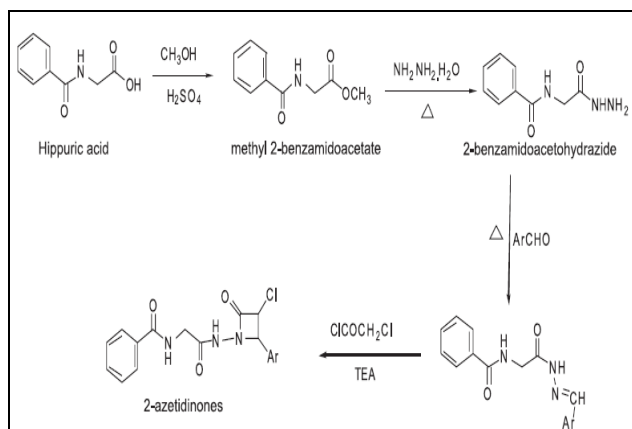
possessed by these compounds, and the best compound was *N*-[2-(3-chloro-2-oxo-4-styrylazetidin-1-ylamino)-2-oxoethyl]benzamide (Deep et al., 2016).

The SAR studies indicate that the existence of electron releasing groups on benzylidene portion will improve the anticancer activity. Cinnamaldehyde derivatives were categorized as the most effective compounds (Deep et al., 2016). These findings are summarized in Fig.11.

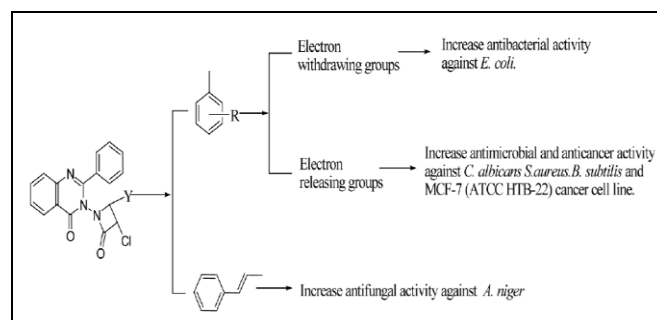


**Fig.12 The structure of Deep and coworker monobactams (B)**

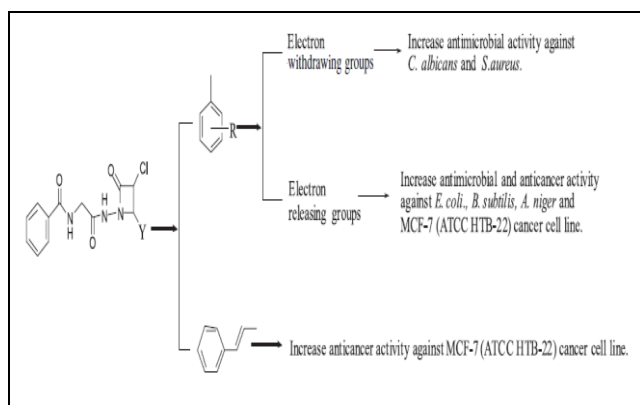
The SAR studies indicate that the presence of electron releasing groups will improve the anticancer activity against human breast cancer cell line (MCF 7) (Fig.13) (Deep et al., 2016).



**Fig.10 The structure of Deep and coworker monobactams (A)**



**Fig.13 The SAR studies of Deep and coworker (B)**



**Fig.11 The SAR studies of Deep and coworker (A)**

Another study for Deep and its coworker (2016) in which they synthesized another monobactam series from hydrazine and chloroacetyl chloride in dimethylformamide (Fig.12). The anticancer activity of synthesized compounds was tested against the human breast cancer cell line (MCF 7). Their results indicated that the synthesized compounds exposed weak anticancer activity against breast cancer cell line (MCF-7) comparing to standard drug (Deep et al., 2016).

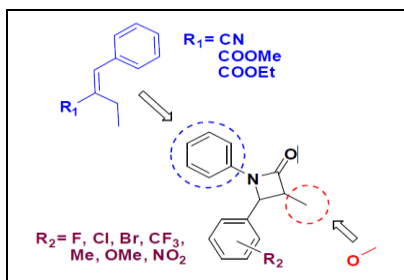
Also in another research, Deep et al. design and synthesis a new series of 4-thiazolidinone derivatives, and evaluate their *in vitro* antimicrobial and anticancer activities. The anticancer study results revealed that *N*-(2-(5-(4-hydroxybenzylidene)-2-(4-methoxyphenyl)-4-oxothiazolidin-3-ylamino)-2-oxoethyl) benzamide was the most powerful anticancer agent (Zhang Y, 2010).

Geesala et al. (2016) synthesized a new monobactams by introducing allyl moieties in stead of aromatic ring on the N1atom of 1,4-diarylazetidin-2-ones, indicating that these allyl (isothiocyanate and disulfide compounds) will give a potent anti cancer effect (Geesala et al., 2016).

The synthesized monobactams were tested by the MTT cell viability assay against human breast cancer cell lines *MCF-7* (ER+/PR+/Her2-, Luminal type) and *MDA MB-231* (ER-/PR-/Her2-, Basal type) and also against non-transformed normal human mammary epithelial cells (MEpiC) (Meenakshi sundaram et al., 2016). The results represent that when fluorine located at the *p*-position of 3-methoxy-2-oxo-4-phenylazetidin will be more active than chlorine or bromine atoms at the same location in the phenyl acrylonitrile derivatives. In addition, the presence of methyl moiety at the *p*-position on the same derivatives was noticed to enhance the antiproliferative activity. It is worth noting that when the methyl moiety located on the *m*-position and also when the second and fifth location occupied by methoxy groups and chlorine located on the *p*-position of these derivatives the activity will decrease. Also they mention that the methyl-

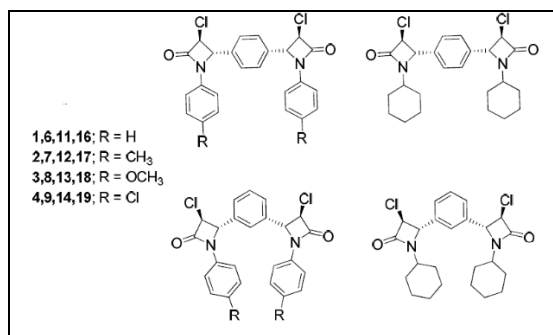
phenyl acrylate compounds of 3-methoxy-2-oxo-4-phenylazetidin bearing either nitro or tri-fluoro methyl group or chlorine atom at *m*-position were ineffective (Fig.14) (Meenakshisundaram et al., 2016).

In another study, Meenakshisundaram et al. (2016) synthesize and evaluate *in vitro* inhibitory activities of new monobactams group against three human cancer cell lines (cervical HeLa, renal ACHN and breast MDA-MB-231). In this study, the dimeric Schiff bases were prepared from terephthalaldehyde and groups of amines (Kayarmar et al., 2017).



**Fig.14** The structure of Geesala *et al.* monobactams

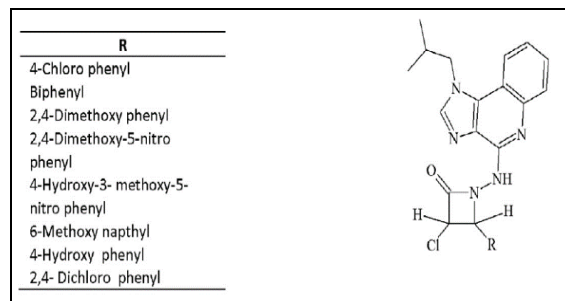
Another group of Schiff bases was created by the reaction of the isophthalaldehyde with another amines. Then the monobactams were synthesized from these Schiff bases (Fig.15) (Kayarmar et al., 2017).



**Fig.15** The structure of Meenakshisundaram *et al.* monobactams

The results indicate that the 1,3-positional isomers of 3-chloroazetidinones revealed strong anticancer activity, and also the 4-methyl derivative exhibited potent cytotoxic activity (Kayarmar et al., 2017).

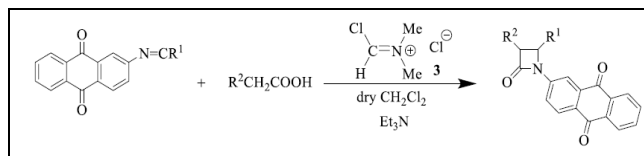
In 2017, a novel group of N-substituted monobactams were synthesized by Kayarmar and its coworker by the reaction of chloroacetyl chloride with 4-arylidene hydrazino-1-isobutyl-1H-imidazo[4,5-c]quinolines compounds. Also by substitute imidazoquinoline at the 4-position they create a group of 3-chloro-4-arylsubstituted-1-[(1-isobutyl-1H-imidazo[4,5-c]quinolin-4yl)amino] azetidin-2-ones (Fig.16) and then they examined the antimicrobial and anticancer activities of these compounds (Mohamadzadeh and Zarei, 2020).



**Fig.16** The structure of Kayarmar *et al.* monobactams

The anticancer activities against the HeLa cancer cell line for the synthesized compounds were compared with cyclophosphamide as standard drug. Compounds with 4-OH phenyl and 2,4-Dichloro phenyl represent the highest anticancer activity against HeLa cells (Mohamadzadeh and Zarei, 2020).

In early 2020, Mohamadzadeh and Zarei synthesize new groups of monobactams having anthraquinone moiety with several substituents (Fig.17) and then they evaluate their antitumor activities. The results showed that many of these monobactams represent reasonable to significant antitumor activity against prostate carcinoma (PC3), colon carcinoma (HCT116), breast carcinoma (MCF7) and neuroblastoma (SKNMC) cell lines via MTT assay. Due to the structural similarity. The reference compound was Doxorubicin (Zhou et al., 2016).



**Fig.17** The structure of Mohamadzadeh and Zarei monobactams

The SAR study reveals that when 2-naphthoxy or methoxy groups substituted on C-3, there will be a higher activity than when substituted at N1, C2 or C4. Little activity was also noticed with chloro, azido, and phthalimido. Reasonable activity is shown by 3-thiolated or -sulfonated derivatives. In addition, cytotoxicity decreased with the replacement of methylthio by methylsulfonyl. The potent cytotoxicity against all cell lines was noticed when 2-azetidinoneanthraquinone hybrids substituted at location 4 by 4-(dimethylamino) phenyl moiety. They concluded that monobactams could be used as antitumor because it's low toxicity and their potent anticancer activities (Zhou et al., 2016).

Another study done by Giolito et al. describes the *in vitro* activity estimation of 35 novel chemical compounds against two negative murine mammary adenocarcinoma tumors. The selection involves two compounds which are  $\beta$ -lactams: PGC22i (penicillin) and CIT171B3 (monobactam) (Fig.18). Both, penicillin and monobactams, have antitumor activity (Nam, 2003; Giolito et al., 2020).

They found that the monobactam compound cause promotion of apoptosis and lower clonogenic capacity. They also decreased the migratory capacity of tumor cells. The results propose the possibility of their future utilization as antitumor and/or antimetastatic agents (Leite et al., 2020).

Grabrijan et al. in their patent overview mentioned the patent from 2011 (WO201107321) in which the authors designate synthetic monobactams derivatives of combretastatin as anti-cancer agents (Grabrijan et al., 2021).

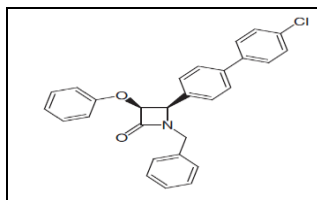


Fig.18 The structure of Giolito et al. monobactams

The rigid beta lactam ring catches the compound in the preferred stereochemistry. The synthesized compounds strongly look like combrestatine, with trimethoxybenzyl at N-1 position, and 2-methoxyphenol at C-4 position. Different groups were presented on C-3 position (Fig.19). The anticancer effect was tested against MCF-7 breast cancer cell line. The reported IC50 values for all compounds were in nanomolar range. In addition, some compound was shown to inhibit the growth of human chronic myeloid leukaemia K562 cells and human promyelocytic leukaemia HL-60 cells, their IC50 were in the nanomolar or sub-nanomolar scope. They conclude that the possibility of using of such compounds as anti-cancer agents would inhibit angiogenesis and metastases (Patil et al., 2021).

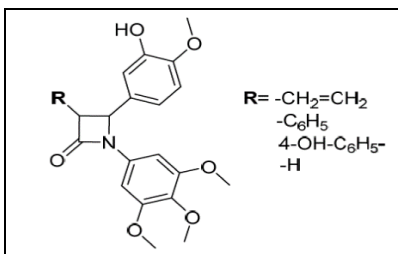


Fig.19 The structure of Grabrijan et al. monobactams

Recently, Patil et al. in their coumarins review study mentioned many bioactive coumarins holding azetidinone and thiazolidinone moieties, which found with a wide range of therapeutic characteristics, including anticancer activities. Azetidinone moieties were added to the positions three, four, six and seven of the coumarin skeleton (Fig.20) (Keri et al., 2010).

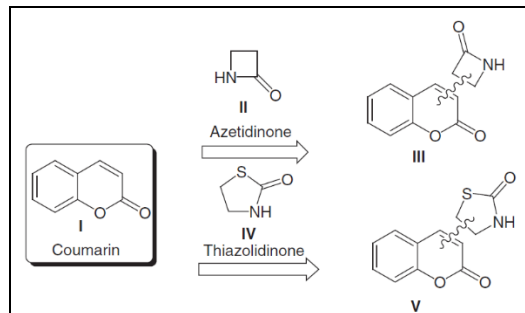


Fig.20 The structure of Patil et al. monobactams

The review mention the synthesis of a new series 3-chloro-4-[4-(2-oxo-2Hchromen-4-ylmethoxy)phenyl]-1-phenylazetidin-2-ones by Keri et al. Compounds 33, 36, 38, 40 and 43 exposed powerful anticancer activity against *Artemia salina* (Fig.21).

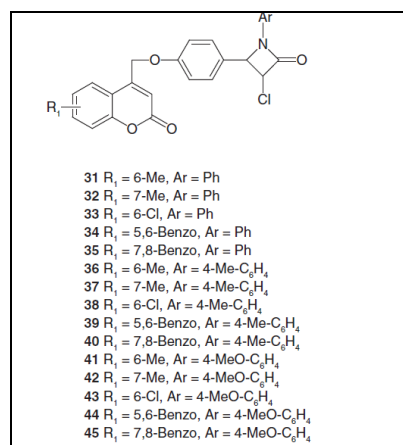


Fig.21 The structure of Keri et al. monobactams

In the same review, another study by Deepika et al. mentioned the design and synthesis of new azetidin-2-one coumarin derivatives (96–99) as anticancer drugs (Fig.22) (Deepika et al., 2020). The docking scores indicated that out of all compounds docked, 96 had the powerfull binding affinity with protein 1XJD. Furthermore, all coumarin azetidinones exhibited good cytotoxic effects against HeLa cancer cell lines. They indicate that these series could be considered to be future leads for anticancer therapy (Głowacka et al., 2021).

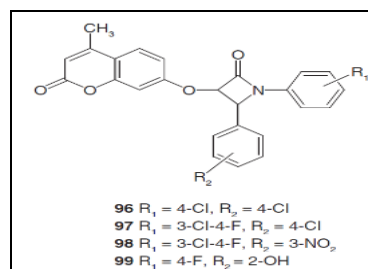
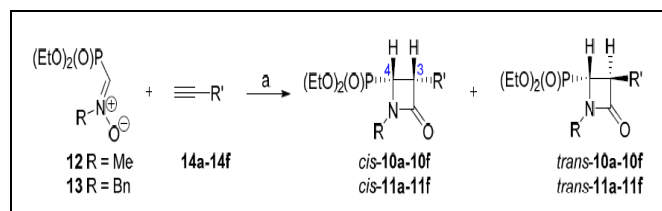


Fig.22 The structure of Deepika et al. monobactams

A new family of N-substituted 3-aryl-4-(diethoxyphosphoryl)azetidin-2-ones was synthesized by Głowacka et al. by reacting the N-methyl- or N-benzyl-(diethoxyphosphoryl)nitron (compounds 12 and 13) with the 14a-14f aryl alkynes (Fig.23) (Fram, 1986).



**Fig.23** The structure of Głowacka et al. monobactams

The 50% cytostatic inhibitory concentration (IC<sub>50</sub>) was estimated against 9 cancerous cell lines: Capan-1 (pancreatic adenocarcinoma), Hap1 (chronic myeloid leukemia), HCT-116 (colorectal carcinoma), DND-41 (acute lymphoblastic leukemia), HL-60 (acute myeloid leukemia), NCI-H460 (lung carcinoma), MM.1S (multiple myeloma), K-562 (chronic myeloid leukemia), normal retina (non-cancerous) cells (hTERT RPE-1), as well as Z-138 non-Hodgkin lymphoma. Some monobactams represent reasonable cytostatic effects concerning Capan-1, Hap1, and HCT-116 cells (Fram, 1986).

Also, Głowacka et al. mentioned a number of compounds and studies that resemble their work as synthesis of 4-(2-chlorophenyl)-3-methoxy-1-(methylthio) azetidin-2-one which stop proliferation and provoke apoptosis in human solid cell lines, like prostate and breast (Chimento et al., 2013). Similarly, 1,4-diaryl-3-chloroazetidin-2-ones which documented as effective compounds against human breast cancer (Smith et al., 2002). Another group of 1,4-diarylazetidinone with methoxyphenyl moiety was synthesized and then evaluated for their cytotoxicity effect by Fuselier and Meegan (Smith et al., 2014). Many of them showed antiproliferative effects against MCF-7 and MDA-MB-231 human breast carcinoma cells with nanomolar value. Furthermore, the fluorinated compounds revealed substantial antitumor effects against HT-29 colon cancer cells (Smith et al., 2014; Malebari et al., 2020).

## Conclusion

Cancer is considered one of the major hazards to human health. It is described as the malignant cells evolution that finally ended with the interference with ordinary physiological works. Anticancer drug investigation concentrates on the reserve of tumor cell development and induction of apoptosis in the malignant cells, without disturbing adjacent cells. However, the low selectivity and the serious chemotherapeutic drugs side effects are the major drawbacks of the current antitumor agents. Therefore there is an urgent need to develop appropriate (safe and selective) chemotherapeutic drugs.

Antibiotics are efficient, mostly well tolerated in patients and have very low level of toxicity. Thus, it may be an attractive target for antitumor agents invention. There are now lots of antitumor antibiotics accepted as anticancer agents. In addition to that, and by varying the character of the electron withdrawing substituent of the monobactams, there is an excellent chance get a safe and effective antitumor monobactams. These records indicate that the designation and synthesis of monobactams represent a talented area for promoting improvement in anticancer fields.

## Conflict of Interest

The author hereby declares no conflict of interest.

## Consent for publication

The author declares that the work has consent for publication.

## Funding support

The author declares that they have no funding support for this study.

## References

- Arya, N., Jagdale, A. Y., Patil, T. A., Yeramwar, S. S., Holikatti, S. S., Dwivedi, J., & Jain, K. S. (2014). The chemistry and biological potential of azetidin-2-ones. *European journal of medicinal chemistry*, 74, 619-656.
- Banik, B. K. (Ed.). (2017). *Beta-lactams: Novel synthetic pathways and applications*. Springer.
- Banik, B. K., Banik, I., & Becker, F. F. (2010). Asymmetric synthesis of anticancer  $\beta$ -lactams via Staudinger reaction: Utilization of chiral ketene from carbohydrate. *European journal of medicinal chemistry*, 45(2), 846-848.
- Banik, I., Becker, F. F., & Banik, B. K. (2003). Stereoselective synthesis of  $\beta$ -lactams with polyaromatic imines: Entry to new and novel anticancer agents. *Journal of medicinal chemistry*, 46(1), 12-15.
- Barrett, I., Carr, M., O'Boyle, N., Greene, L. M., JS Knox, A., Lloyd, D. G., & Meegan, M. J. (2010). Lead identification of conformationally restricted benzoxepin type combretastatin analogs: synthesis, antiproliferative activity, and tubulin effects. *Journal of enzyme inhibition and medicinal chemistry*, 25(2), 180-194.
- Bimal K B (2014) Personal perspectives on medicinal and pharmaceutical chemistry. *Frontiers in chemistry*, 8, 1-3.
- Borazjani, N., Sepehri, S., Behzadi, M., Jarrahpour, A., Rad, J. A., Sasanipour, M. & Turos, E. (2019). Three-component synthesis of chromeno  $\beta$ -lactam hybrids for inflammation and cancer screening. *European journal of medicinal chemistry*, 179, 389-403.
- Cainelli, G., Galletti, P., Garbisa, S., Giacomini, D., Sartor, L., & Quintavalla, A. (2003). 4-Alkylidene-azetidin-2-ones: novel inhibitors of leukocyte elastase and gelatinase. *Bioorganic & medicinal chemistry*, 11(24), 5391-5399.
- Carr, M., Greene, L. M., Knox, A. J., Lloyd, D. G., Zisterer, D. M., & Meegan, M. J. (2010). Lead identification of conformationally restricted  $\beta$ -lactam type combretastatin analogues: Synthesis, antiproliferative activity and tubulin targeting effects. *European journal of medicinal chemistry*, 45(12), 5752-5766.
- Cerić, H., Šindler-Kulyk, M., Kovačević, M., Perić, M., & Živković, A. (2010). Azetidinone-isothiazolidinones: Stereoselective synthesis and antibacterial evaluation of new monocyclic beta-lactams. *Bioorganic & medicinal chemistry*, 18(9), 3053-3058.
- Chavan, A. A., & Pai, N. R. (2007). Synthesis and biological activity of N-substituted-3-chloro-2-azetidinones. *Molecules*, 12(11), 2467-2477.



- Chen, D., Falsetti, S. C., Frezza, M., Milacic, V., Kazi, A., Cui, Q. C. & Dou, Q. P. (2008). Anti-tumor activity of N-thiolated  $\beta$ -lactam antibiotics. *Cancer letters*, 268(1), 63-69.
- Chimento, A., Sala, M., Gomez-Monterrey, I. M., Musella, S., Bertamino, A., Caruso, A., & Pezzi, V. (2013). Biological activity of 3-chloro-azetidin-2-one derivatives having interesting antiproliferative activity on human breast cancer cell lines. *Bioorganic & medicinal chemistry letters*, 23(23), 6401-6405.
- Chin, J. R., Murphy, G., & Werb, Z. (1985). Stromelysin, a connective tissue-degrading metalloendopeptidase secreted by stimulated rabbit synovial fibroblasts in parallel with collagenase. Biosynthesis, isolation, characterization, and substrates. *Journal of Biological Chemistry*, 260(22), 12367-12376.
- Decuyper, L., Jukić, M., Sosić, I., Žula, A., D'hooghe, M., & Gobec, S. (2018). Antibacterial and  $\beta$ -lactamase inhibitory activity of monocyclic  $\beta$ -Lactams. *Medicinal research reviews*, 38(2), 426-503.
- Deep, A., Kumar, P., Narasimhan, B., Lim, S. M., Ramasamy, K., Mishra, R. K., & Mani, V. (2016). 2-Azetidinone derivatives: synthesis, antimicrobial, anticancer evaluation and QSAR studies. *Acta Pol Pharm Drug Res*, 73, 65-78.
- Deep, A., Kumar, P., Narasimhan, B., Meng, L. S., Ramasamy, K., Mishra, R. K., & Mani, V. (2016). Synthesis, antimicrobial and anticancer evaluation of 2-azetidinones clubbed with quinazolinone. *Pharmaceutical Chemistry Journal*, 50(1), 24-28.
- Deep, A., Kumar, P., Narasimhan, B., Lim, S. M., Ramasamy, K., Mishra, R. K. and Mani, V. (2016) Synthesis, antimicrobial, anticancer evaluation and qsar studies of thiazolidin-4-one derivatives. *Acta Pol Pharm. Jan-Feb 2016*;73(1):93-106.
- Deepika, P., Dhanya, P., & Naseef, P. P. (2020). Docking investigation, synthesis and cytotoxic studies of coumarin substituted azetidinone derivatives. *Research Journal of Pharmacy and Technology*, 13(12), 6182-6185.
- Dong, J., Huang, G., Zhang, Q., Wang, Z., Cui, J., Wu, Y. & Li, S. (2019). Development of benzochalcone derivatives as selective CYP1B1 inhibitors and anticancer agents. *MedChemComm*, 10(9), 1606-1614.
- Dražić, T., Kopf, S., Corridan, J., Leuthold, M. M., Bertosa, B., & Klein, C. D. (2019). Peptide- $\beta$ -lactam inhibitors of dengue and west nile virus NS2B-NS3 protease display two distinct binding modes. *Journal of medicinal chemistry*, 63(1), 140-156.
- El-Shorbagi, A. N., & Chaudhary, S. (2019). Monobactams: A Unique Natural Scaffold of Four-Membered Ring Skeleton, Recent Development to Clinically Overcome Infections by Multidrug-Resistant Microbes. *Letters in Drug Design & Discovery*, 16(12), 1305-1320.
- Fram, R. J. (1986). A comparison of the effects of cytosine arabinoside and beta-lactams on DNA synthesis and cellular proliferation. *Cell biology and toxicology*, 2(4), 531-539.
- Frezza, M., Garay, J., Chen, D., Cui, C., Turos, E., & Dou, Q. P. (2008). Induction of tumor cell apoptosis by a novel class of N-thiolated  $\beta$ -lactam antibiotics with structural modifications at N1 and C3 of the lactam ring. *International journal of molecular medicine*, 21(6), 689-695.
- Fu, D. J., Fu, L., Liu, Y. C., Wang, J. W., Wang, Y. Q., Han, B. K., ... & Liu, H. M. (2017). Structure-activity relationship studies of  $\beta$ -lactam-azide analogues as orally active antitumor agents targeting the tubulin colchicine site. *Scientific reports*, 7(1), 1-12.
- Galletti, P., & Giacomini, D. (2011). Monocyclic  $\beta$ -lactams: new structures for new biological activities. *Current medicinal chemistry*, 18(28), 4265-4283.
- Geesala, R., Gangasani, J. K., Budde, M., Balasubramanian, S., Vaidya, J. R., & Das, A. (2016). 2-Azetidinones: Synthesis and biological evaluation as potential anti-breast cancer agents. *European journal of medicinal chemistry*, 124, 544-558.
- Giolito, M. V., Camacho, C. M., Martinez-Amezaga, M., Traficante, C. I., Giordano, R. A., Cornier, P. G., & Rico, M. J. (2020). Antitumor activity of new chemical compounds in triple negative mammary adenocarcinoma models. *Future science OA*, 6(3), FSOA442.
- Głowacka, I. E., Grabkowska-Drużyc, M., Andrei, G., Schols, D., Snoeck, R., Witek, K., Podlewska, S., Handzlik, J. and Piotrowska, D. G. (2021). Novel N-Substituted 3-Aryl-4-(diethoxyphosphoryl) azetidin-2-ones as Antibiotic Enhancers and Antiviral Agents in Search for a Successful Treatment of Complex Infections. *Int. J. Mol. Sci.*, 22, 8032.
- Grabrijan, K., Strašek, N., & Gobec, S. (2021). Monocyclic beta-lactams for therapeutic uses: a patent overview (2010–2020). *Expert Opinion on Therapeutic Patents*, 31(3), 247-266.
- Greene, T. F., Wang, S., Greene, L. M., Nathwani, S. M., Pollock, J. K., Malebari, A. M., & Meegan, M. J. (2016). Synthesis and biochemical evaluation of 3-phenoxy-1, 4-diarylazetidin-2-ones as tubulin-targeting antitumor agents. *Journal of medicinal chemistry*, 59(1), 90-113.
- Hammersley, D., & Signy, M. (2017). Ezetimibe: an update on its clinical usefulness in specific patient groups. *Therapeutic advances in chronic disease*, 8(1), 4-11.
- Hodge, M., Chen, Q. H., Bane, S., Sharma, S., Loew, M., Banerjee, A. & Kingston, D. G. (2009). Synthesis and bioactivity of a side chain bridged paclitaxel: A test of the T-Taxol conformation. *Bioorganic & medicinal chemistry letters*, 19(10), 2884-2887.
- Hojilla, C. V., Mohammed, F. F., & Khokha, R. (2003). Matrix metalloproteinases and their tissue inhibitors direct cell fate during cancer development. *British journal of cancer*, 89(10), 1817-1821.
- Jain, A. K., Vaidya, A., Ravichandran, V., Kashaw, S. K., & Agrawal, R. K. (2012). Recent developments and biological activities of thiazolidinone derivatives: a review. *Bioorganic & medicinal chemistry*, 20(11), 3378-3395.
- Kamath, A., & Ojima, I. (2012). Advances in the chemistry of  $\beta$ -lactam and its medicinal applications. *Tetrahedron*, 68(52), 10640.
- Kayarmar, R., Nagaraja, G. K., Naik, P., Manjunatha, H., Revanasiddappa, B. C., & Arulmoli, T. (2017). Synthesis and characterization of novel imidazoquinoline based 2-azetidinones as potent antimicrobial and anticancer agents. *Journal of Saudi Chemical Society*, 21, S434-S444.
- Kazi, A., Hill, R., Long, T. E., Kuhn, D. J., Turos, E., & Dou, Q. P. (2004). Novel N-thiolated  $\beta$ -lactam antibiotics selectively induce apoptosis in human tumor and transformed, but not normal or nontransformed, cells. *Biochemical pharmacology*, 67(2), 365-374.
- Keri, R. S., Hosamani, K. M., Reddy, H. S., & Shingalapuri, R. V. (2010). Synthesis, in-vitro Antimicrobial and Cytotoxic Studies of Novel Azetidinone Derivatives. *Archiv der Pharmazie: An International Journal Pharmaceutical and Medicinal Chemistry*, 343(4), 237-247.
- Koch, V., Lorion, M. M., Barde, E., Bräse, S., & Cossy, J. (2019). Cobalt-catalyzed  $\alpha$ -arylation of substituted  $\alpha$ -halogeno  $\beta$ -lactams. *Organic letters*, 21(16), 6241-6244.
- Kondratyuk, T. P., Park, E. J., Marler, L. E., Ahn, S., Yuan, Y., Choi, Y., & Pezzuto, J. M. (2011). Resveratrol derivatives as promising chemopreventive agents with improved potency and selectivity. *Molecular nutrition & food research*, 55(8), 1249-1265.
- Kuhn, D., Coates, C., Daniel, K., Chen, D., Bhuiyan, M., Kazi, A. & Dou, Q. P. (2004). Beta-lactams and their potential use as novel anticancer chemotherapeutics drugs. *Front Biosci*, 9, 2605-2617.
- Kumar, A., Rajput, C. S., & Bhati, S. K. (2007). Synthesis of 3-[4'-(p-chlorophenyl)-thiazol-2'-yl]-2-[(substituted azetidinone/thiazolidinone)-aminomethyl]-6-bromoquinazolin-4-ones as anti-inflammatory agent. *Bioorganic & medicinal chemistry*, 15(8), 3089-3096.
- Leite, T. H., Saraiva, M. F., Pinheiro, A. C., & de Souza, M. V. N. (2020). Monocyclic  $\beta$ -Lactam: A Review on Synthesis and Potential Biological Activities of a Multitarget Core. *Mini reviews in medicinal chemistry*, 20(16), 1653-1682.
- Lima, L. M., da Silva, B. N. M., Barbosa, G., & Barreiro, E. J. (2020).  $\beta$ -lactam antibiotics: An overview from a medicinal chemistry perspective. *European Journal of Medicinal Chemistry*, 112829.
- Mahmood, A. A. (2021). Synthesis, antioxidant and antimicrobial activities for new 4, 4'-methylenedianiline amide compounds. *Egyptian Journal of Chemistry*, 64(12), 2-3.
- Mahmood, A. A., Al-Iraqi, M. A., & Abachi, F. T. (2021). Design, synthesis and anti- $\beta$ -lactamase activity for new monobactam compounds. *Materials Today: Proceedings*, 42, 1860-1866.
- Malebari, A. M., Fayne, D., Nathwani, S. M., O'Connell, F., Noorani, S., Twamley, B., & Meegan, M. J. (2020).  $\beta$ -Lactams with antiproliferative and antiapoptotic activity in breast and chemoresistant colon cancer cells. *European journal of medicinal chemistry*, 189, 112050.
- Malig, T. C., Yu, D., & Hein, J. E. (2018). A Revised Mechanism for the Kinugasa Reaction. *Journal of the American Chemical Society*, 140(29), 9167-9173.
- Martelli, G., Bloise, N., Merlettini, A., Bruni, G., Visai, L., Focarete, M. L., & Giacomini, D. (2020). Combining biologically active  $\beta$ -lactams integrin agonists with poly (l-lactic acid) nanofibers: enhancement of

- human mesenchymal stem cell adhesion. *Biomacromolecules*, 21(3), 1157-1170.
- Meegan, M. J., Carr, M., Knox, A. J., Zisterer, D. M., & Lloyd, D. G. (2008).  $\beta$ -Lactam type molecular scaffolds for antiproliferative activity: Synthesis and cytotoxic effects in breast cancer cells. *Journal of enzyme inhibition and medicinal chemistry*, 23(5), 668-685.
- Meegan, M. J., Hughes, R. B., Lloyd, D. G., Williams, D. C., & Zisterer, D. M. (2001). Flexible estrogen receptor modulators: design, synthesis, and antagonistic effects in human MCF-7 breast cancer cells. *Journal of medicinal chemistry*, 44(7), 1072-1084.
- Meenakshisundaram, S., Manickam, M., & Vinayagam, V. (2016). Synthesis, antibacterial and anticancer activity of novel bis-azetidiones. *J. Chem. Pharm. Res*, 8(2), 733-742.
- Mehta, P. D., Sengar, N. P. S., Pathak, A. K. (2010). 2-Azetidinone-a new profile of various pharmacological activities. *Eur J Med Chem* 45:5541–5560. <https://doi.org/10.1016/j.ejmech.2010.09.035>
- Mohamadzadeh, M. and Zarei, M. (2020) Anticancer activity and evaluation of apoptotic genes expression of 2-azetidiones containing anthraquinone moiety. *Mol Divers*, 2021 Nov;25(4):2429-2439.
- Nam, N. H. (2003). Combretastatin A-4 analogues as antimitotic antitumor agents. *Current Medicinal Chemistry*. 2003 Sep;10(17):1697-1722.
- O'Boyle, N. M., Carr, M., Greene, L. M., Bergin, O., Nathwani, S. M., McCabe, T., & Meegan, M. J. (2010). Synthesis and evaluation of Sharipova, R. R., Belenok, M. G., Garifullin, B. F., Sapunova, A. S., Voloshina, A. D., Andreeva, O. V. & Kataev, V. E. (2019). Synthesis and anti-cancer activities of glycosides and glycoconjugates of diterpenoid isosteviol. *MedChemComm*, 10(8), 1488-1498.
- Singh, G. S. (2003). Recent progress in the synthesis and chemistry of azetidiones. *Tetrahedron*, 59(39), 7631-7649.
- Smith, D. M., Kazi, A., Smith, L., Long, T. E., Heldreth, B., Turos, E., & Dou, Q. P. (2002). A novel  $\beta$ -lactam antibiotic activates tumor cell apoptotic program by inducing DNA damage. *Molecular pharmacology*, 61(6), 1348-1358.
- Smith, S. R., Douglas, J., Prevet, H., Shapland, P., Slawin, A. M., & Smith, A. D. (2014). Isothiourea-catalyzed asymmetric synthesis of  $\beta$ -lactams and  $\beta$ -amino esters from arylacetic acid derivatives and N-sulfonylaldimines. *The Journal of organic chemistry*, 79(4), 1626-1639.
- Söderström, T. S., Poukkula, M., Holmström, T. H., Heiskanen, K. M., & Eriksson, J. E. (2002). Mitogen-activated protein kinase/extracellular signal-regulated kinase signaling in activated T cells abrogates TRAIL-induced apoptosis upstream of the mitochondrial amplification loop and caspase-8. *The Journal of Immunology*, 169(6), 2851-2860.
- Sun, L., Vasilevich, N. I., Fuselier, J. A., Hocart, S. J., & Coy, D. H. (2004). Examination of the 1, 4-disubstituted azetidione ring system as a template for combretastatin A-4 conformationally restricted analogue design. *Bioorganic & medicinal chemistry letters*, 14(9), 2041-2046.
- Tanaka, T., Muto, T., Maruoka, H., Imajo, S., Fukami, H., Tomimori, Y., & Nakatsuka, T. (2007). Identification of 6-substituted 4-arylsulfonyl-1, 4-diazepane-2, 5-diones as a novel scaffold for human chymase inhibitors. *Bioorganic & medicinal chemistry letters*, 17(12), 3431-3434.
- Tikhomirov, A. S., Shtil, A. A., Shchekotikhin, A. E. (2018). Advances in the discovery of anthraquinone-based anticancer agents. *Recent Pat Anticancer Drug Discov* 13:159–183. <https://doi.org/10.2174/1574892813666171206123114>
- Tripodi, F., Dapiaggi, F., Orsini, F., Pagliarin, R., Sello, G., & Coccetti, P. (2018). Synthesis and biological evaluation of new 3-amino-2-azetidione derivatives as anti-colorectal cancer agents. *MedChemComm*, 9(5), 843-852.
- azetidione analogues of combretastatin A-4 as tubulin targeting agents. *Journal of medicinal chemistry*, 53(24), 8569-8584.
- Ojima, I., & Delalogue, F. (1997). Asymmetric synthesis of building-blocks for peptides and peptidomimetics by means of the  $\beta$ -lactam synthon method. *Chemical Society Reviews*, 26(5), 377-386.
- Olazaran, F. E., Rivera, G., Pérez-Vázquez, A. M., Morales-Reyes, C. M., Segura-Cabrera, A., & Balderas-Rentería, I. (2017). Biological evaluation in vitro and in silico of azetidion-2-one derivatives as potential anticancer agents. *ACS medicinal chemistry letters*, 8(1), 32-37.
- Pathak, R. B., Chovatia, P. T., & Parekh, H. H. (2012). Synthesis, antitubercular and antimicrobial evaluation of 3-(4-chlorophenyl)-4-substituted pyrazole derivatives. *Bioorganic & medicinal chemistry letters*, 22(15), 5129-5133.
- Patil, S. A., Patil, S. A., Fariyike, T., Marichev, K. O., Heras Martinez, H. M., & Bugarin, A. (2021). Medicinal applications of coumarins bearing azetidione and thiazolidinone moieties. *Future Medicinal Chemistry*, 13(21), 1907-1934.
- Petrovski, G., Gurusamy, N., & Das, D. K. (2011). Resveratrol in cardiovascular health and disease. *Annals of the New York Academy of Sciences*, 1215(1), 22-33.
- Pettit, G. R., Smith, C. R., & Singh, S. B. (1987). Recent advances in the chemistry of plant antineoplastic constituents. *Biologically active natural products/edited by K. Hostettmann and PJ Lea*.
- Tripodi, F., Pagliarin, R., Fumagalli, G., Bigi, A., Fusi, P., Orsini, F. & Coccetti, P. (2012). Synthesis and biological evaluation of 1, 4-diaryl-2-azetidiones as specific anticancer agents: activation of adenosine monophosphate activated protein kinase and induction of apoptosis. *Journal of medicinal chemistry*, 55(5), 2112-2124.
- Trivedi, A. R., Desai, J. M., Dholariya, B. H., Dodiya, D. K., & Shah, V. H. (2012). Synthesis and antimicrobial evaluation of novel benzo [b] thiophenes comprising  $\beta$ -lactam nucleus. *Medicinal Chemistry Research*, 21(7), 1471-1479.
- Valtorta, S., Nicolini, G., Tripodi, F., Meregalli, C., Cavaletti, G., Avezza, F. & Coccetti, P. (2014). A novel AMPK activator reduces glucose uptake and inhibits tumor progression in a mouse xenograft model of colorectal cancer. *Investigational new drugs*, 32(6), 1123-1133.
- Vento, S., & Cainelli, F. (2003). Infections in patients with cancer undergoing chemotherapy: aetiology, prevention, and treatment. *The lancet oncology*, 4(10), 595-604.
- Wilhelm, S. M., Collier, I. E., Kronberger, A., Eisen, A. Z., Marmer, B. L., Grant, G. A., ... & Goldberg, G. I. (1987). Human skin fibroblast stromelysin: structure, glycosylation, substrate specificity, and differential expression in normal and tumorigenic cells. *Proceedings of the National Academy of Sciences*, 84(19), 6725-6729.
- Zhang, Y. (2010). Allyl isothiocyanate as a cancer chemopreventive phytochemical. *Molecular nutrition & food research*, 54(1), 127-135.
- Zhou, P., Liang, Y., Zhang, H., Jiang, H., Feng, K., Xu, P. & Wang, Y. (2018). Design, synthesis, biological evaluation and cocrystal structures with tubulin of chiral  $\beta$ -lactam bridged combretastatin A-4 analogues as potent antitumor agents. *European journal of medicinal chemistry*, 144, 817-842.
- Zhou, P., Liu, Y., Zhou, L., Zhu, K., Feng, K., Zhang, H., & Wang, Y. (2016). Potent antitumor activities and structure basis of the chiral  $\beta$ -lactam bridged analogue of combretastatin A-4 binding to tubulin. *Journal of medicinal chemistry*, 59(22), 10329-10334.
- Zhuang, C., Zhang, W., Sheng, C., Zhang, W., Xing, C., & Miao, Z. (2017). Chalcone: a privileged structure in medicinal chemistry. *Chemical reviews*, 117(12), 7762-7810.

**How to cite this article**

Ahmed A. J. Mahmood (2022). Monobactams as anticancer: a review study. *Science Archives*, Vol. 3 (1), 1-10. <http://dx.doi.org/10.47587/SA.2022.3101>

This work is licensed under a [Creative Commons Attribution 4.0 International License](https://creativecommons.org/licenses/by/4.0/)



**Publisher's Note:** MD International Publishing stays neutral with regard to jurisdictional claims in published maps and institutional affiliations.